

Fisher & Paykel

Dishwasher
DW60CE and DW60CC models

**Installation instructions
and User guide**

NZ AU SG

Safety and warnings	3
Installation instructions	6
Introduction	14
Using your dishwasher – quick reference	15
<i>CE models</i>	
Controls and starting a wash	16
<i>CC models</i>	
Controls and starting a wash	20
Changing the wash programme	22
Setting Delay start	23
Changing the wash zone	24
User preference settings	25
Caring for your dinnerware	26
Loading	27
Water hardness and dishwashing	31
Wash programmes and detergent quantities	32
Adding detergent	33
Using rinse aid	34
After the wash	35
Care and cleaning	36
Fault codes	38
Troubleshooting	39
Warranty and service	42
Wash programme data	43
Standards test	44

Important!

SAVE THESE INSTRUCTIONS

The models shown in this user guide may not be available in all markets and are subject to change at any time. For current details about model and specification availability in your country, please visit our local website listed on the back cover or contact your local Fisher & Paykel dealer.

Your dishwasher has been carefully designed to operate safely during normal dishwashing procedures. Please keep the following instructions in mind when you are using your dishwasher.

Important safety instructions

- *For your safety, follow basic precautions when using your dishwasher, including the following:*
- *Please read all instructions before operating your dishwasher.*
- *The information in this user guide must be followed to minimise the risk of fire or explosion, or to prevent property damage, personal injury or loss of life.*

Installation

- *This dishwasher must be installed and positioned in accordance with the 'Installation instructions' before it is used.*
- *Installation and service should be performed by a qualified technician.*
- *If the power supply cord is damaged, it must be replaced by the manufacturer or Authorised Service Centre or a similarly qualified person in order to avoid a hazard.*
- *Ensure the dishwasher is placed between cabinetry. Failure to do so may result in an unstable product, which may cause damage or injury.*
- *Do not operate this dishwasher if it is damaged, malfunctioning, partially disassembled or has missing or broken parts, including a damaged power supply cord or plug.*
- *Do not store or use petrol or other flammable vapours and liquids in the vicinity of the dishwasher.*
- *Connect to a properly rated, protected and sized power supply circuit to avoid electrical overload.*
- *Make sure that the power supply cord is positioned where it will not be stepped on, tripped over, or otherwise subjected to damage or stress.*
- *Do not install or store the dishwasher where it will be exposed to the weather or temperatures below freezing.*
- *Do not use an extension cord or portable electrical outlet device (eg multi-socket outlet box) to connect the dishwasher to the power supply.*

Important safety instructions

Operational

- *Use the dishwasher only for its intended function as described in this user guide.*
- *This appliance is intended to be used in household and similar applications such as:*
 - *staff kitchen areas in shops, offices and other working environments;*
 - *farm houses;*
 - *by clients in hotels, motels and other residential type environments;*
 - *bed and breakfast type environments.*
- *Some dishwasher detergents are strongly alkaline. They can be extremely dangerous if swallowed. Avoid contact with the skin and eyes and keep children away from the dishwasher when the door is open. Check that the detergent receptacle is empty after completion of the wash cycle.*
- *Use only detergents and rinse aid recommended for use in a domestic dishwasher and keep them out of reach of children.*
- *When loading items to be washed, place sharp items where they are not likely to damage the dishwasher and load sharp knives with the handles up to reduce the risk of cut type injuries.*
- *Do not tamper with the controls of your dishwasher.*
- *Do not abuse, sit on, or stand on the door or dish rack of your dishwasher. Do not place any heavy objects on the door when it is open. The dishwasher could tip forward.*
- *To reduce the risk of injury, do not allow children to play in or on the dishwasher.*
- *Under certain conditions hydrogen gas may be produced in a hot water heater system that has not been used for two weeks or more. HYDROGEN GAS IS EXPLOSIVE. If the hot water system has not been used for such a period, then before using the dishwasher, turn on all hot water taps and let the water flow from each for several minutes. This will release any accumulated hydrogen gas.*
- *As hydrogen gas is flammable, do not smoke or use an open flame during this time.*
- *Remove the door to the washing compartment when removing an old dishwasher from service or discarding it.*
- *Open the door very carefully if the dishwasher is in operation. There is a risk of being sprayed with hot water. Do not open the door fully until the spray arms have stopped rotating.*
- *The door should not be left in the open position as this could present a tripping hazard.*
- *When disconnecting the dishwasher pull by the plug rather than the cord or junction of cord to avoid damage.*
- *This dishwasher is not intended for use by young children or infirm persons unless they have been adequately supervised by a responsible person to ensure that they can use the dishwasher safely.*
- *Young children should be supervised to ensure that they do not play with the dishwasher.*
- *The water inside the dishwasher is not suitable for drinking.*
- *This dishwasher is designed for washing normal household utensils. Items that are contaminated by petrol, paint, steel or iron debris, or corrosive, acidic or alkaline chemicals are not to be washed in this dishwasher.*
- *If the dishwasher is not being used for long periods of time, turn the electricity and water supply to the dishwasher off.*

Important safety instructions

Maintenance

- *Do not repair or replace any part of the dishwasher or attempt any servicing unless specifically recommended in this user guide. We recommend that you call a Fisher & Paykel Authorised Service Agent.*
- *Keep the floor around your dishwasher clean and dry to reduce the possibility of slipping.*
- *Keep the area around and underneath your dishwasher free from the accumulation of combustible materials, such as lint, paper, rags and chemicals.*
- *When cleaning the underside of the filter plate, take care on the sharp outer edge to avoid the risk of cut type injuries.*
- *If the dishwasher is not operating properly or maintenance must be performed, disconnect the dishwasher from the power supply.*

Before you start

Safety and compliance

- These instructions are intended as a guide only. It is the responsibility of the installer to ensure that installation complies with applicable regulations and local government by-laws.
- Installation must be performed by a suitably qualified person. Incorrect installation or malfunctioning resulting from incorrect installation are not covered by warranty.
- Carefully read through the 'Safety and warnings' section of this document.
- The dishwasher must not be connected to the electrical supply while it is being installed. Ensure all domestic wiring is properly earthed.
- If an old appliance is being replaced, make sure it is disposed of properly. To avoid children getting trapped or injured while playing with an old appliance, ensure you remove any doors, door locks and cables from it.
- In order to ensure that the dishwasher is stable, it must be installed under a continuous surface which is attached to adjacent cupboards.

Unpacking and handling

- Check packaging and dishwasher for signs of transport damage. If the dishwasher is in any way damaged, do not install it. Contact the dealer the dishwasher was purchased from.
- Disposal of packaging: some of the packaging is recyclable. Check the symbols and labels and recycle if possible.
- Never lift the dishwasher from the door handle or the top panel. Doing so may cause damage.
- Always be careful with the hoses and power cord at the back of the dishwasher. Careful handling will prevent damage and malfunction from squashing, kinking or cuts.
- While installing the dishwasher, check the drain hose is not restricted or kinked.

Connections and services

- Check that the power cord is long enough to reach the outlet. If it isn't, it must be replaced by a Fisher & Paykel authorised technician. Extension cords or multi-outlet power boards should not be used to connect the dishwasher to the power supply.
- Check that the hoses are long enough to reach the services. If a hose needs extending, ensure that the extension hose is new and of equal quality and diameter to the one already fitted. Note: the drain hose should not be longer than 4 m, as a longer drain hose will cause reduced performance.
- The dishwasher should not be connected to a water system where the temperature exceeds 60°C, or where there is no temperature control, e.g. wetback system, unless the system is fitted with a suitable tempering valve.
- The dishwasher must not be connected to an undersink high-pressure "push-through" type hot water system, as damage to the system will result.

Technical data

Check the electrical data on the rating label (located on the left-hand side of the dishwasher's stainless steel inner door). Should the data on the rating label be different to those specified below, consider those on the rating label as correct.

<i>Capacity</i>	<i>14 standard place settings</i>
<i>Mains water pressure</i>	<i>0.03-1 MPa (= 0.3-10 bar)</i>
<i>Power voltage</i>	<i>220-240 V (50 Hz)</i>
<i>Maximum current intensity</i>	<i>10 A</i>
<i>Total absorbed power</i>	<i>1800-1950 W</i>
<i>Colour</i>	<i>white (DW60CEW, DW60CCW) or stainless steel(DW60CEX, DW60CCX)</i>

Anti-flood protection

This dishwasher has anti-flood protection, which will stop the water flowing in the event of a leak within the machine.

Product and cabinetry dimensions

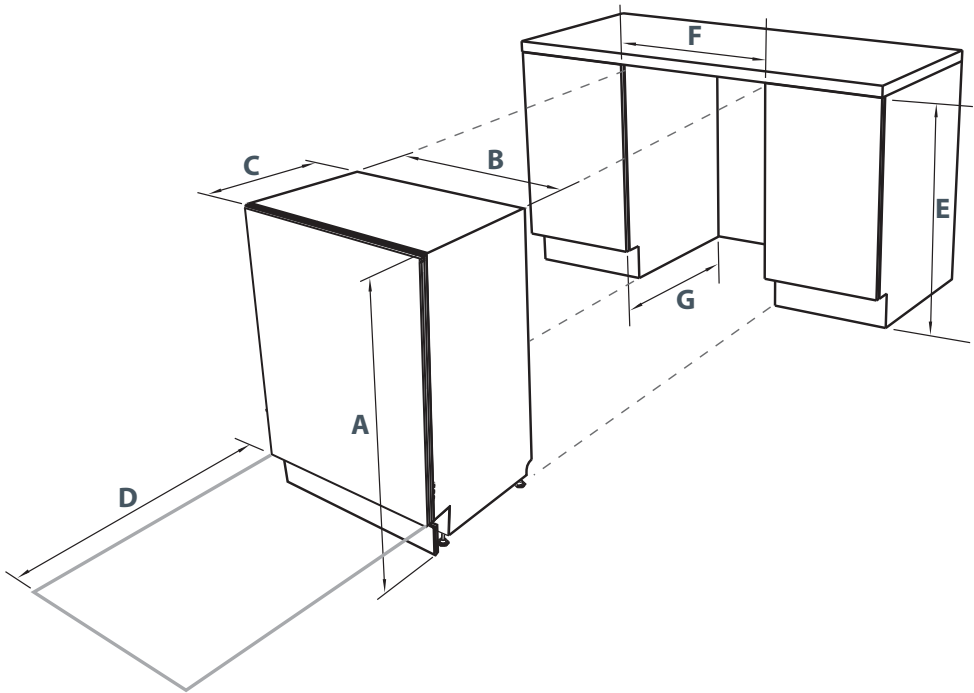

Product dimensions (mm)		
A	overall height of product <i>with top panel in place</i> <i>with top panel removed*</i>	850 (min) -870 (max)** 820 (min) -840 (max)**
B	overall width of product	595
C	overall depth of product	600
D	depth of open door (measured from front of kickstrip)	595
Cabinetry dimensions (mm)		
E	inside height of cavity <i>with top panel in place</i> <i>with top panel removed*</i>	855 (min) -875 (max)** 825 (min) -845 (max)**
F	inside width of cavity	600
G	inside depth of cavity	605

* The top panel may be removed to suit underbench cavity height. See instructions further below.

** Depending on feet height adjustment.

Preparing the product and cabinetry

- The top panel may be removed to suit underbench cavity height. See the illustrations below.

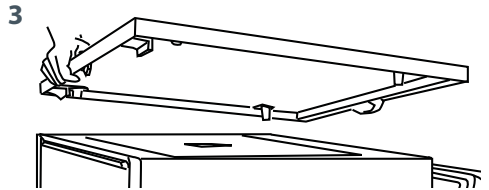
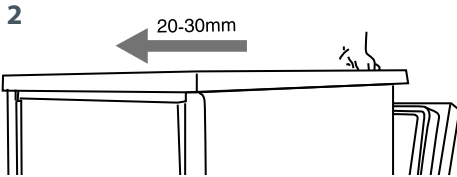
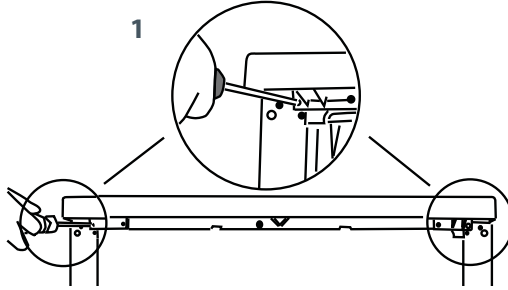

Important!

To prevent possible steam damage to the cabinetry, ensure that any bare wood surrounding the dishwasher is sealed with an oil-based paint or moisture-proof polyurethane.

- Services can be located either side of the dishwasher. Ensure that the services hole has a minimum diameter of 50 mm.

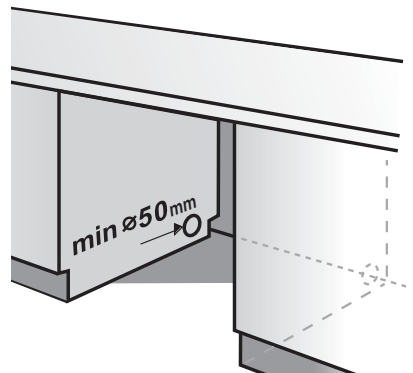

Levelling and positioning the dishwasher

- Before sliding the dishwasher into position, adjust the feet with a spanner (1) to ensure that the dishwasher is level (2) and the required height.
- Do not lift the dishwasher from the door handle or top panel.
- Position the dishwasher in the cavity, ensuring that the hoses and power cord don't get bent, crimped, or trapped under the dishwasher in the process (3).
- If you install the dishwasher with the top panel removed, we recommend that you fix the dishwasher to the bench using the top brackets, as shown (4).

Important!

Ensure that you do not damage the bench by using fixing screws that are too long for it.

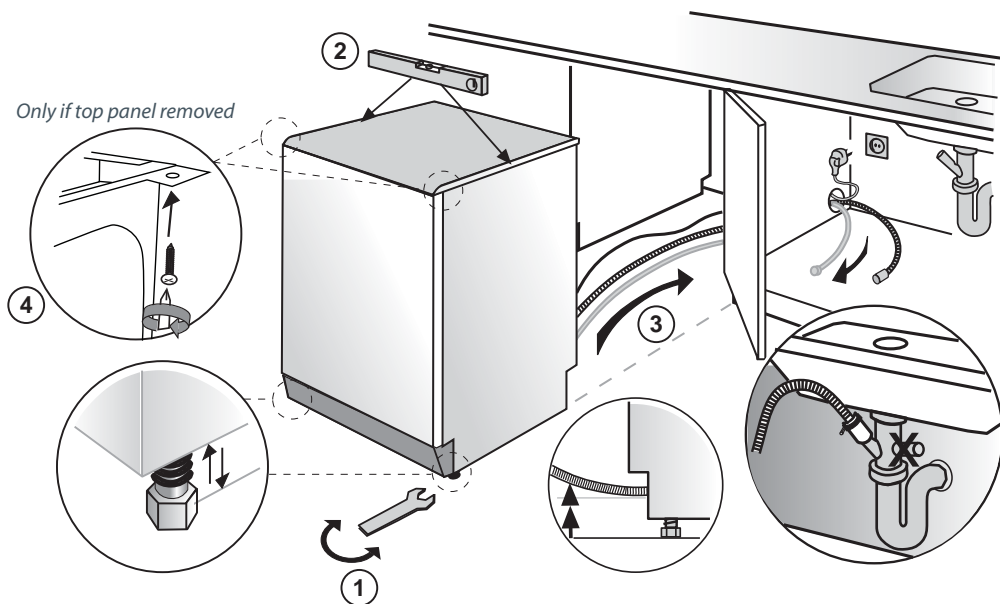

Plumbing -- Waste connection

These drainage options are designed to eliminate problems that occur with combined sink-dishwasher waste systems.

Drainage option A: Separate sink and dishwasher waste systems

- The standpipe must have a minimum diameter of 38 mm and stand 750 mm above the floor.
- Use the supplied drain hose support to hold the drain hose in place in the standpipe.

Important!

We do not recommend connecting the drain hose or drain pipe directly to a built-in waste disposal unit.

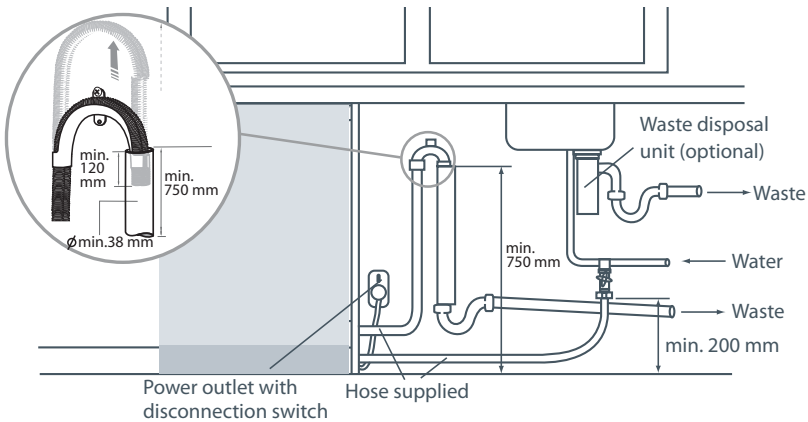

Drainage option B: Combined sink and dishwasher waste systems

- When connecting the drain hose to a sink trap with a drain hose spigot, make sure that the drain hose is supported to the height of the bench.
- Ensure the drain spigot has a minimum hole diameter of 15 mm and it has been drilled out.
- Secure the drain hose connection with the clip supplied.

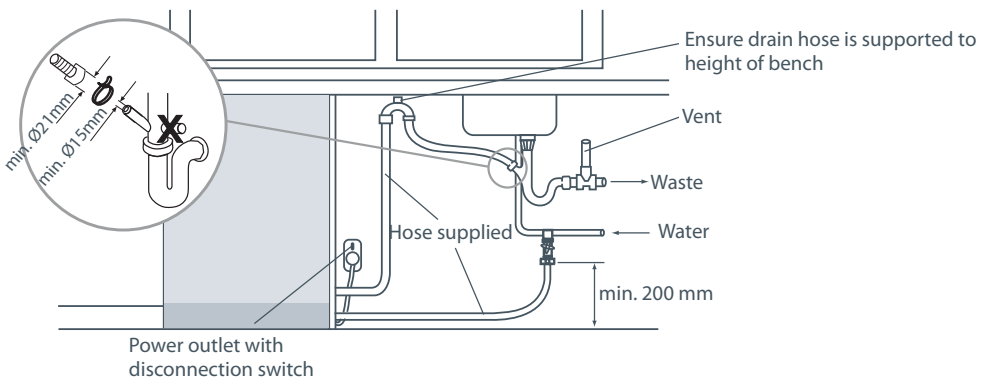

Plumbing -- Water inlet connection

Important!

- *The appliance should be connected to the water main using the new water inlet hose supplied. Old hoses should not be used.*
 - *Do not shorten the inlet hose.*
- 1 Take note of water connection requirements.
 - The dishwasher has a single valve water connection.
 - We recommend a cold water connection for best performance and energy efficiency.
 - The incoming water temperature should not exceed 60°C.
 - 2 Take note of the permitted water pressure extremes.
 - Lowest: 0.3 bar = 3 N/cm² = 30kPa
 - Where pressure is below 1 bar, contact a qualified plumber.
 - Highest: 10 bar = 100 N/cm² = 1MPa
 - Where pressure is above 10 bar, a pressure reduction valve must be installed. Contact a qualified plumber.
 - 3 Connect the water inlet hose to an accessible water tap with a 3/4" BSP connector. Ensure that there is no kink in the inlet hose that could restrict the flow of water. A 90° bend requires a minimum height of 200 mm for a kink-free curve.
 - Ensure incoming water is clear. If the water pipes have not been used for a long period of time, let the water run to make sure it is clear with no impurities. Not doing so may result in the water inlet hose getting blocked and damaging the appliance.
 - If required, use a filter insert to filter out deposits from the piping. The filter insert is available from your Authorised Service Centre or Customer Care.
 - 4 Tighten the hose coupling a further half turn after seal contact.
 - 5 Check that the connection does not leak.

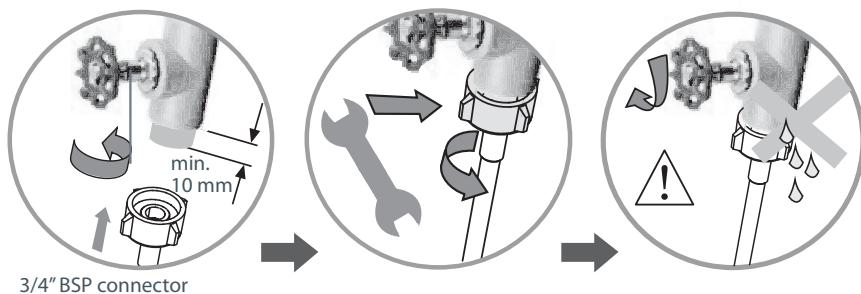

Electrical connection

- The dishwasher must not be connected to the electrical supply while installation is being carried out. Ensure all domestic wiring is properly earthed.
- Check the rating label (located on the left-hand side of the dishwasher's stainless steel inner door) and ensure that the voltage and frequency values for the current in the house correspond to those on the rating label.
- Insert the plug into a properly earthed power outlet that has a disconnection switch.

Important!

- *The earthing of the appliance is a safety requirement mandated by law.*
- *If the power cord is not long enough to reach the outlet or the outlet to which the appliance must be connected is not appropriate for the plug, the entire dishwasher power cord must be replaced. This should only be done by a Fisher & Paykel authorised technician. Do not modify or cut the plug. Do not use an adaptor, extension cord, or multi-outlet power board to connect the dishwasher to the power supply, as these could cause overheating and create a fire hazard.*
- *The outlet into which the dishwasher is plugged must remain easily accessible (e.g. in an adjacent cabinet) even when the appliance is installed. This is to ensure that the dishwasher can be disconnected from the power supply for safe cleaning and maintenance.*

Installer final checklist

- Check that the door opens and closes freely without resistance to adjacent cabinetry.
- Check that the plug is accessible.
- Check that the dishwasher is level. If necessary, adjust the levelling feet slightly. To ensure optimum performance, the dishwasher should not be inclined more than 2°. Check with a spirit level.
- Check the operation of the dishwasher:
 - 1 Press **ⓘ** to turn the dishwasher on.
 - 2 Select the Rinse programme.
CE models: Press **▶▶** until Rinse is selected.
CC models: See section 'Changing the wash programme' for instructions.
 - 3 Press **▶||** to start the Rinse programme.
Can you hear the dishwasher filling?
 - 4 When the Rinse programme is over (approx. 12 minutes), check that the water has drained.

If a fault code appears, see the 'Fault codes' section of the user guide for advice.

Before you start

- Make sure the installer has completed the 'Final checklist' in the Installation instructions.
- Read this manual thoroughly, taking special note of the 'Safety and warnings' section.
- Remove all the packaging and check that you have all the accessories listed below.

Dishwasher features and accessories

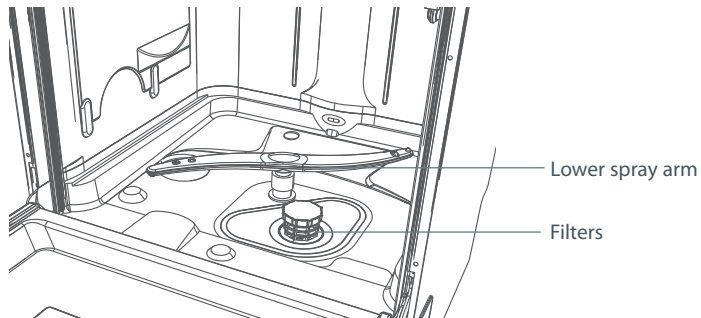
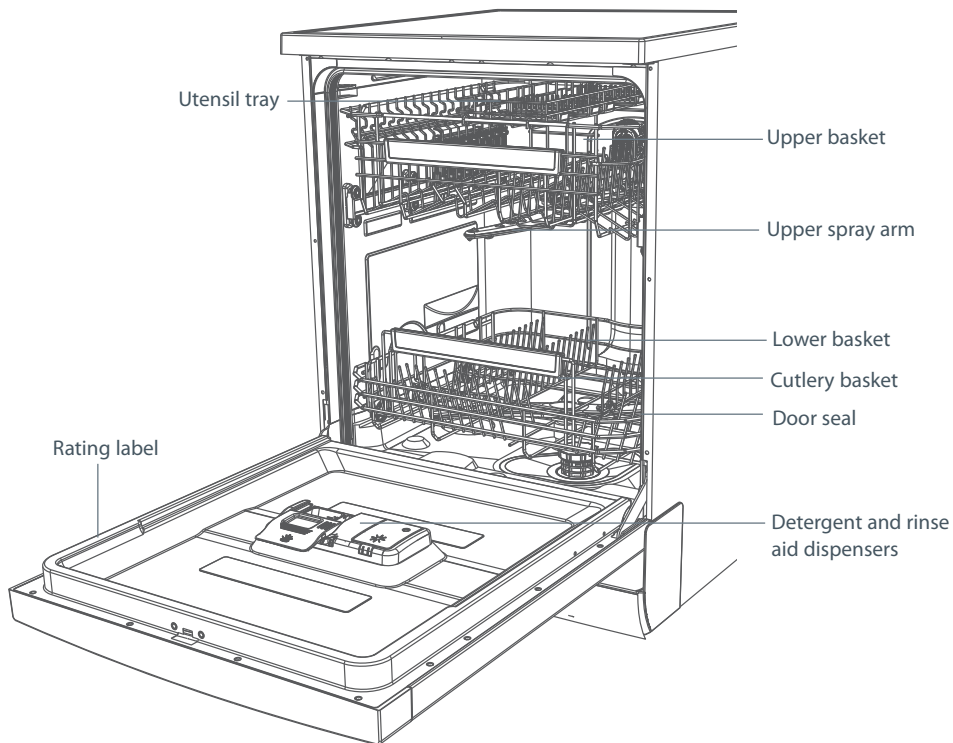

Starting a wash

1 Remove food scraps and load dishes carefully

*For more detail, see sections
'Caring for your dinnerware'
'Loading'*

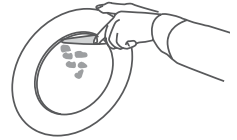

2 Add detergent

*For more detail, see sections
'Water hardness and dishwashing'
'Wash programmes and detergent quantities'
'Adding detergent'*

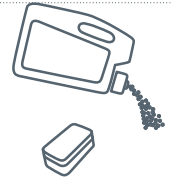

3 Turn power on (check also if water is on)

*For more detail, see section
'Controls and starting a wash'*



4 Check rinse aid level, refill if necessary

*For more detail, see section
'Using rinse aid'*



5 Check that nothing obstructs the spray arms, then close the door firmly

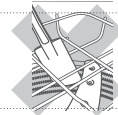

6 Select wash programme

*For more detail, see section
'Controls and starting a wash'
'Wash programmes and detergent quantities'
'Changing the wash programme' (CC models only)*

CE models ▶ heavy normal normal eco fast delicate rinse



CC models



7 Start wash OR set Delay start

*For more detail, see section
'Controls and starting a wash'
'Setting Delay start' (CC models only)*



After the wash

8 Open the door slightly and leave ajar to help drying

*For more detail, see section
'After the wash'*

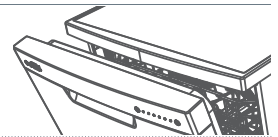

9 Once cooled, unload dishes carefully

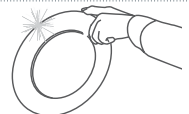

*For more detail, see section
'After the wash'*



10 Check condition of dishwasher, clean if necessary

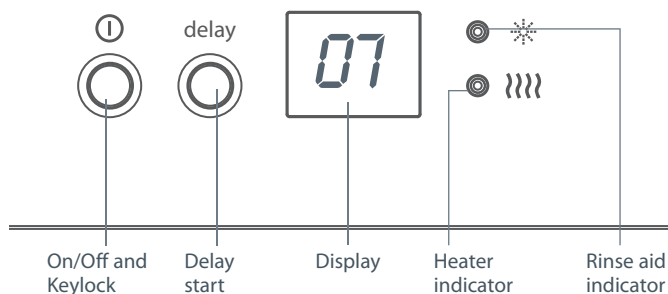

16 Controls and starting a wash - CE models

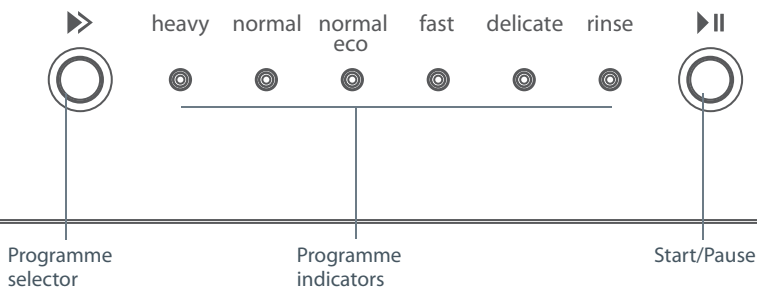

Control panel feature		Action to take	
	On/Off	Turns the power to the dishwasher on and off.	Press I briefly to turn the dishwasher on and off.
	Keylock	This disables all the buttons so a wash cannot accidentally be started e.g. by children playing, someone leaning against the control panel, or during cleaning.	To activate or cancel Keylock, press and hold I for 3 seconds (until you hear a long beep). LDC will show in the display when the Keylock has been activated.
delay	Delay start	Delay start is useful if you want to set your dishwasher to start a wash programme automatically later (e.g. while you are away from home).	To set Delay start, press the delay button until the display shows the desired delay time (in hours). The counting will restart after 12 hours.
07	Display	This shows: <ul style="list-style-type: none"> the remaining wash time in minutes the delay time in hours (if Delay start is set) fault codes Keylock has been activated (LDC will be displayed). 	
	Rinse aid indicator	This will light up when the rinse aid level is low.	When the indicator lights up, refill rinse aid. See 'Using rinse aid' for instructions.
	Heater indicator	This will light up when the dishwasher is heating the water.	



To select and start a wash programme

- 1 Make sure that the dishwasher is powered on .
- 2 Press  until the indicator of the desired programme lights up.
- 3 Press  to start the programme.
 - After 5 seconds, the selected programme indicator will start flashing, the dishwasher will beep once and the wash will start automatically.
 - The display will show the approximate time remaining.
 - Note: the dishwasher will remember the last programme used.

To pause and restart a wash programme

- 1 Press  to pause the programme.
- 2 Open the door very slowly.

Important!

There is a risk of being sprayed with hot water. Do not fully open the door until the spray arms have stopped rotating.

- 3 Load, remove, or rearrange any dishes if needed.
- 4 Check that there is no excessive steam, then close the door.

Important!

If the programme is paused when the dishwasher has already heated the water, leave the door ajar for several minutes before closing it again; if you don't, the expanding steam inside could force the door open.

- 5 Press  to restart the programme.

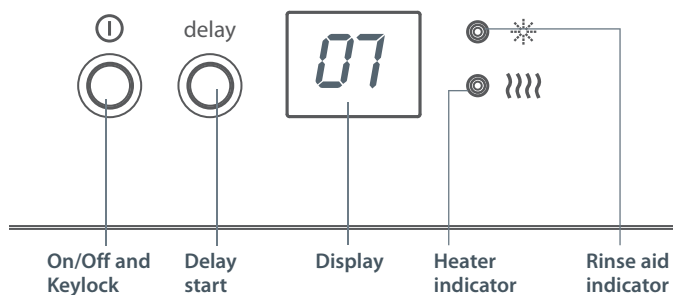

To cancel a wash programme once it has started

- 1 Press ►|| to pause the programme.
- 2 Press ① to turn the dishwasher off.

The programme has now been cancelled. If you wish, you can start a different one. Note: you may need to refill the detergent dispenser.

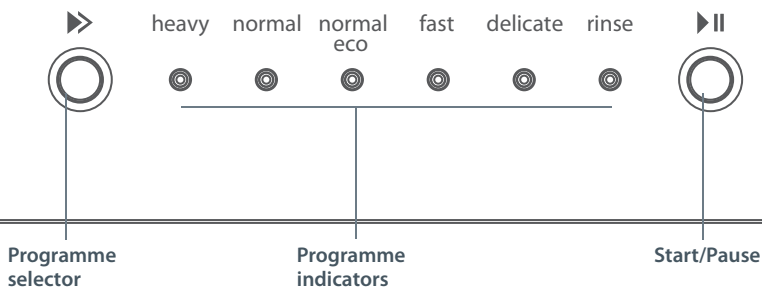

Delay start

This feature can delay the start of a wash programme by 1 to 12 hours.

To activate Delay start:

- 1 Load the dishes, add detergent and close the door.
- 2 Press **ⓘ** to turn the dishwasher on.
- 3 Select the wash programme.
- 4 Press the delay button. The display will change to *1H*. Press the button until the display shows the required delay (each press increases the delay by 1 hour).
- 5 Press **▶||** to begin the Delay start.

The display will flash and count down the time remaining. The wash programme will automatically start when the delay time is over.

To cancel Delay start, press **ⓘ**.

Keylock

This feature disables all the buttons on the dishwasher.

To activate Keylock, press and hold **ⓘ** for 3 seconds. The dishwasher will beep and the display will show *LDC* to indicate that Keylock has been activated.

To cancel Keylock, press and hold **ⓘ** for 3 seconds. The dishwasher will beep and *LDC* will disappear from the display to indicate that Keylock has been cancelled.

If any other buttons are pressed while Keylock is activated, the dishwasher will display *LDC* and emit a beep.

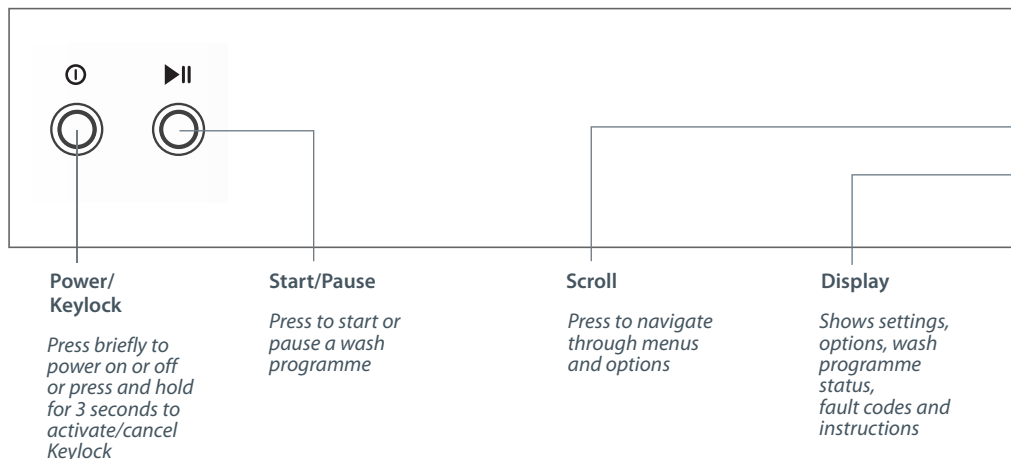

To start a wash programme

- 1 Make sure that the dishwasher is powered on on ⓘ .
- 2 Check that the wash programme displayed is the one you would like to use. If not, see section 'Changing the wash programme.'
- 3 Once the display shows the programme you would like to use, press ▶|| to start the programme. The display will show the approximate time remaining and the stage of the wash.
Note: the dishwasher will remember the last programme used.

To pause and restart a wash programme

- 1 Press ▶|| to pause the programme.
- 2 Open the door very slowly.

Important!

There is a risk of being sprayed with hot water. Do not fully open the door until the spray arms have stopped rotating.

- 3 Load, remove, or rearrange any dishes if needed.
- 4 Check that there is no excessive steam, then close the door.

Important!

If the programme is paused when the dishwasher has already heated the water, leave the door ajar for several minutes before you close it again; if you don't, the expanding steam inside could force the door open.

- 5 Press ▶|| to restart the programme.

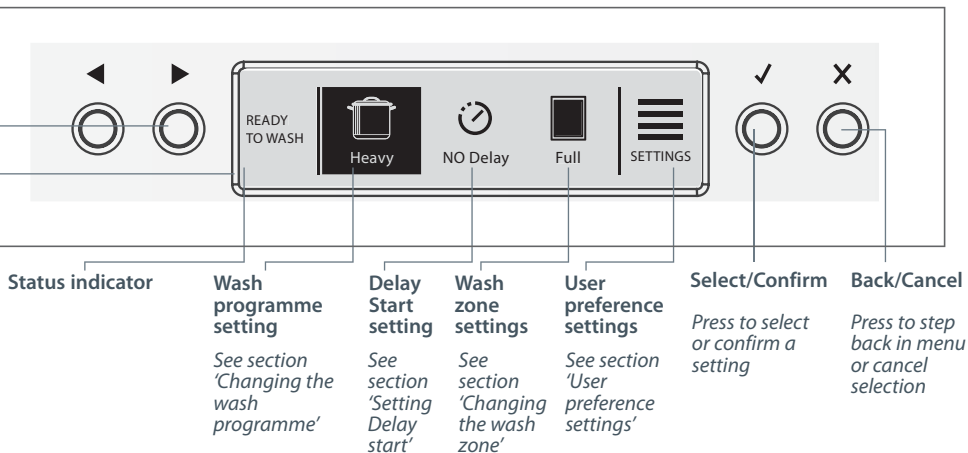

To cancel a wash programme once it has started

- 1 Press ▶|| to pause the programme.
- 2 Press ⏻ to turn the dishwasher off.

The programme has now been cancelled. If you wish, you can start a different one. Note: you may need to refill the detergent dispenser.

Keylock

This feature disables all the buttons on the dishwasher.



To activate Keylock, press and hold ⏻ for 3 seconds. The dishwasher will beep and the status indicator will show the 🔒 icon.

To cancel Keylock, press and hold ⏻ for 3 seconds. The dishwasher will beep and the 🔒 icon will disappear.

If any other buttons are pressed while Keylock is activated, the dishwasher will emit a beep.

22 Changing the wash programme - CC models

Note: The dishwasher will remember the last programme used.

- 1 Make sure that the dishwasher is powered on .
- 2 Scroll   to highlight the icon of the wash programme last used.

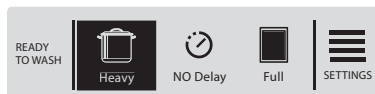

- 3 Press  to enter the wash programme menu.

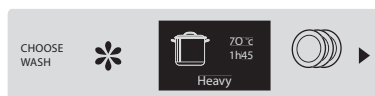

- 4 Scroll   to highlight the new wash programme you want.

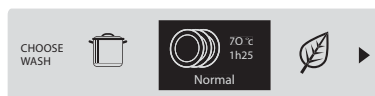

Wash programme descriptions



Auto

Senses the optimal wash programme for your dishes



Heavy

A wash for heavily soiled dishes



Normal

A wash for your everyday dishes



Normal Eco

Helps you save energy and water for everyday dishes



Fast

A fast wash for lightly soiled dishes



Delicate

For all your heat sensitive dishes



Rinse

Prevents food from drying on dishes



Hygiene

A wash for sanitising your dishes

- 5 Press  to confirm the selection. You will be taken back to the main screen.

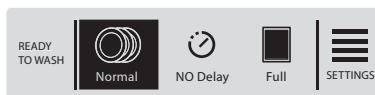

Note: at any step, you may use the  button to go back to the previous menu.

This feature can delay the start of a wash programme by 1 to 24 hours.

- 1 Load the dishes, add detergent and close the door.
- 2 Press **1** to turn the dishwasher on.
- 3 Check that the display shows the wash programme you require. If not, see instructions for 'Changing the wash programme'.

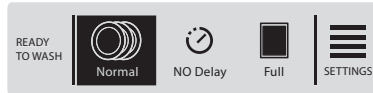

- 4 Scroll **◀ ▶** to highlight the 'Delay' icon.

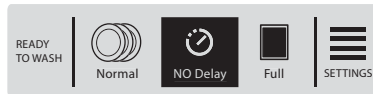

- 5 Press **✓** to enter the Delay start setting.



- 6 Scroll **◀ ▶** to highlight the number of hours you wish to delay the wash by.



- 7 Press **✓** to confirm the delay time. You will be taken back to the main screen.

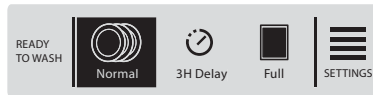

- 8 Press **▶||** to start the countdown. The wash programme will automatically start when the delay time is over.





To cancel Delay start, turn power to the dishwasher off and on again, then follow steps 4 to 6 above, selecting the 'No Delay' option.

*Note: at any step, you may use the **X** button to go back to the previous menu.*

24 Changing the wash zone - CC models

If you don't have a full load and want to save energy and water, you can choose to wash the lower basket or upper basket only. This may be useful if, for example, you only wish to wash the breakfast dishes which are in the upper basket.

- 1 Make sure that the dishwasher is powered on .
- 2 Scroll   to highlight the icon of the wash zone currently set.



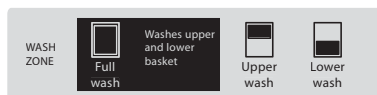

- 3 Press  to enter the menu.



- 4 Scroll   to highlight the required wash zone, then press  to confirm.



- 5 You will be asked if you wish to save the new wash zone setting for the future. Scroll   to highlight the option you want, then press  to confirm.

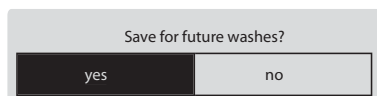

You will be taken back to the main screen, and the wash zone you selected will now be displayed.

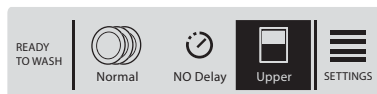



Note: at any step, you may use the  button to go back to the previous menu.

- These allow you to:
- optimise your dishwasher for the type of detergent you use
 - turn rinse aid on or off
 - have the temperature displayed in °C or °F
 - adjust screen brightness and contrast
 - turn the beeps on or off
 - reset the dishwasher to original factory settings.

1 Make sure that the dishwasher is powered on .

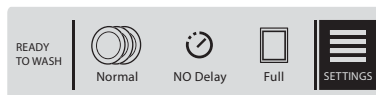
2 Scroll   to highlight the 'Settings'  icon.



3 Press  to enter the menu.

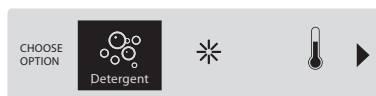

4 Scroll   to highlight the option whose setting you want to change.

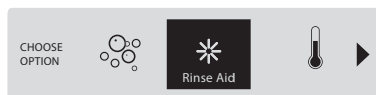

User preference options

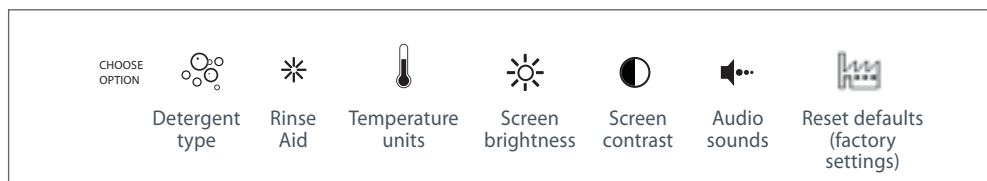

5 Press  to select the option.

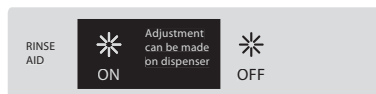

6 Scroll   to select the new setting.

7 Press  to confirm. The dishwasher will confirm that the setting has been changed, and you will be taken back to the main screen.

Note: at any step, you may use the  button to go back to the previous menu.

The combination of high temperatures and dishwasher detergent may cause damage to some items if they are washed in the dishwasher. Remember, if in any doubt about any aspect concerning items washed in the dishwasher, follow the instructions from the manufacturer of the items, or wash the item by hand.

Important!

Never put highly absorbent materials, such as sponges and towels in your dishwasher. Do not put dishes or cutlery that have been soiled by tobacco ash, wax, lubricating grease or paint in your dishwasher.

Cutlery and silverware

All cutlery and silverware should be rinsed immediately after use to prevent tarnishing caused by some foods. Silver items should not come into contact with stainless steel, e.g. other cutlery. Mixing these items can cause staining. Remove silver cutlery from the dishwasher and hand dry immediately after the programme has finished.

Aluminium

Aluminium can be dulled by dishwasher detergent. The degree of change depends on the quality of the item.

Other metals

Iron and cast iron objects can rust and stain other items. Copper, pewter and brass tend to stain. Wash these items by hand.

Woodware

Wooden items are generally sensitive to heat and water. Regular use in the dishwasher may cause deterioration over time. If in doubt, wash by hand.

Glassware

Most everyday glassware is dishwasher safe. Crystal, very fine and antique glassware may etch that is, become opaque. You may prefer to wash these items by hand.

Plastic

Some plastic may change shape or colour with hot water. Check the manufacturer's instructions about washing plastic items. Washable plastic items should be weighted down so they do not flip over and fill with water or fall through the basket during the wash.

Decorated items

Most modern china patterns are dishwasher safe. Antique items, those with a pattern painted over the glaze, gold rims or hand-painted china may be more sensitive to machine washing. If in doubt, wash by hand.

Glued items

Certain adhesives are softened or dissolved in machine washing. If in doubt, wash by hand.

DOs	DON'Ts
<ul style="list-style-type: none">▪ Arrange the dishes neatly, spacing them evenly for maximum exposure to water.▪ Remove any large food particles before placing dishes in the dishwasher. This is to prevent the filters from becoming clogged.▪ Pre-soak any pots and pans with baked-on residue. This will eliminate the need for extra wash cycles.▪ Always check that water can reach all areas, particularly the cup racks.▪ Make sure all items are stable and cannot move during the wash. Any flimsy or light plastic items should be either weighted down or placed in the utensil tray.▪ Ensure there are no dishware items that will stop the spray arm from rotating.	<ul style="list-style-type: none">▪ <i>Don't overcrowd the dishwasher. This will reduce performance.</i>▪ <i>Don't allow plates and cutlery to nest.</i>▪ <i>Don't let dishware block water from reaching items on the cup racks.</i>

Upper basket and utensil tray

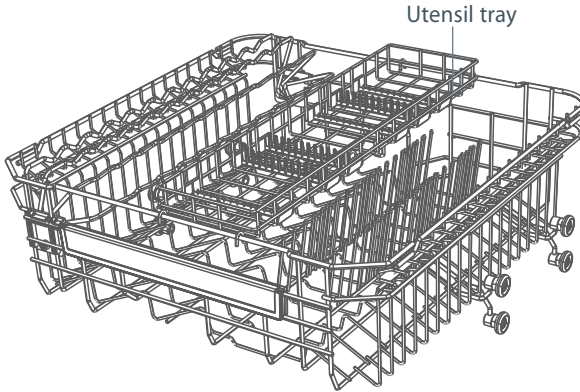

- The upper basket is designed to hold items like glasses, cups, saucers, plates, small bowls and shallow pans.
- Use the utensil tray to securely hold long or sharp items like knives, chopsticks, or ladles. Ensure that knife blades are facing down.
- Slide or remove the utensil tray if you need the space for other items below.
- You can adjust the height of the upper basket to create more space for tall items in the lower basket. See below.

Adjusting the height of the upper basket - CE models

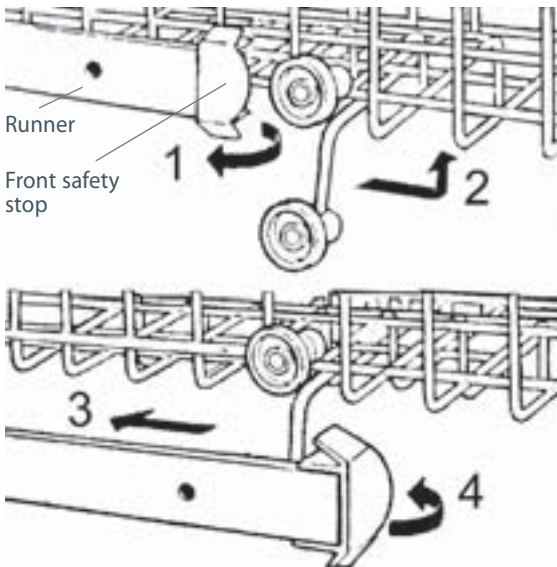

Important!

Before you adjust its height, make sure the basket is empty.

- 1 Turn the front safety stops on either side outwards.
- 2 Slide the empty basket out of the runners.
- 3 Reinsert the higher or lower set of rollers in the runners and slide the basket all the way back in.
- 4 Turn the front safety stops inwards.

Adjusting the height of the upper basket - CC models

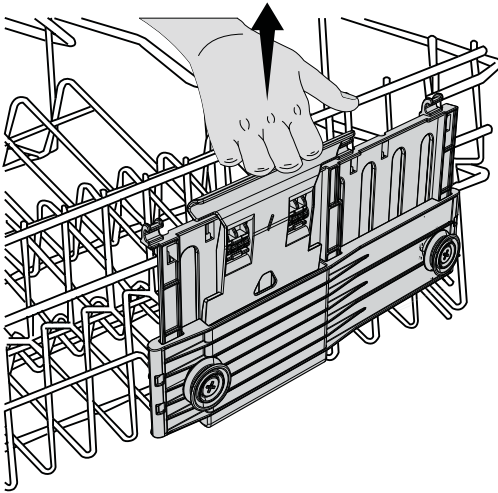

- You can adjust the height of the upper basket even when it is fully loaded, as you do not have to remove it from the dishwasher.
- **To lift the basket,** hold it on one side and carefully pull upwards until it clicks into place. Repeat for the other side.

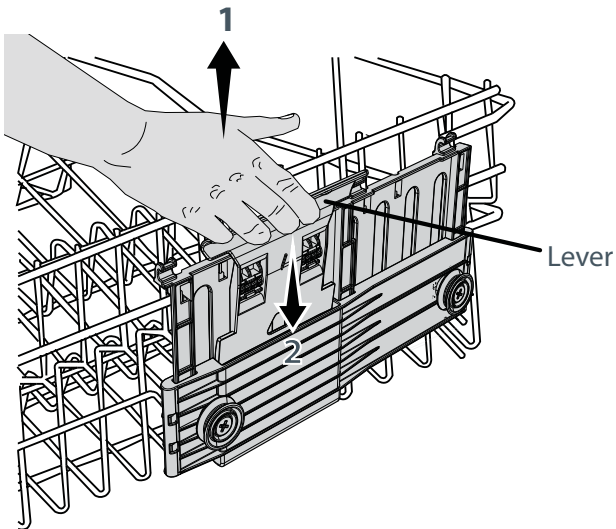

- **To lower the basket,** pull the lever up on one side and, without releasing it, carefully let the basket drop down. Repeat for the other side.

Lower basket

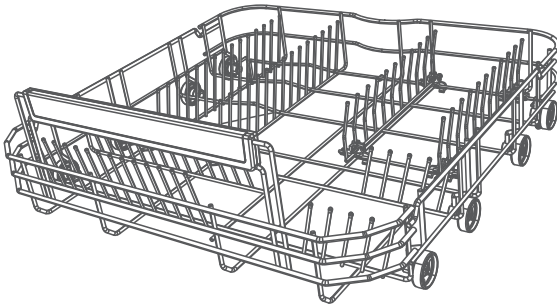

- Place the largest items here: pots, pans, lids, serving dishes and bowls.
- Fold down the tines to place pots and pans flat on the bottom.
- Ensure dishware items do not block the spray arm above from rotating.
- If you need more height for tall items, you can raise the upper basket. See instructions on previous pages.

Cutlery basket

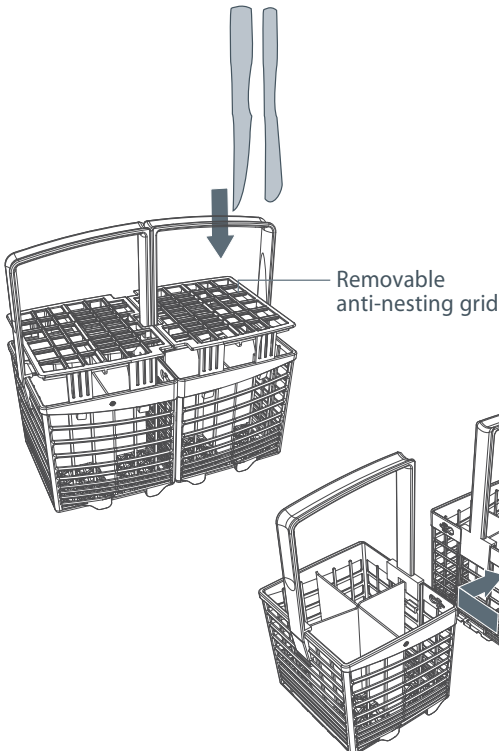

- To reduce the risk of injury, we recommend loading knives and sharp utensils with handles facing up.
- Mix spoons, knives and forks within each section to stop cutlery nesting together and to ensure the water circulates freely. Alternatively, use the clip-on anti-nesting grids to keep cutlery items apart.
- Keep stainless steel from touching silver cutlery to avoid staining.
- You can halve the cutlery basket as shown and use just one section. This is useful if the cutlery load is light or if you want to make more space for other dishes.

What is water hardness?

Hard water is water with a high concentration of minerals such as calcium and magnesium. In soft water, this concentration is low. Water hardness varies by geographical location.

How does water hardness affect dishwashing?

- Hard water can be detrimental to the performance of your dishwasher. Over time, glassware washed in hard water will become opaque and dishes will become spotted or covered in a white film. Using very hard water can cause dishwasher parts to fail over time.
- Naturally soft or softened water has no detrimental effects if used with the correct amount of detergent. However, excess detergent combined with hot, soft water may cause irreversible etching on glassware. Etching first appears as a rainbow-coloured film and—if allowed to continue—can make glassware permanently opaque.

What can I do to minimise any detrimental effects?

Contact your local water company to find out about water hardness in your area.

If your home has hard water ...

- Increase the amount of detergent used.
- Use a detergent with high phosphate content. Phosphate softens the water and this improves wash results. You could also try using multi-purpose tablets.
- Use rinse aid. We recommend you turn the rinse aid setting to 5 to help improve wash performance.
- Use a dishwasher cleaner/descaler regularly, or whenever you notice a build-up of limescale deposits in your dishwasher.

Important!









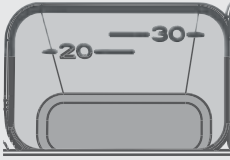

We recommend fitting a water softener to the household water supply. If the water hardness in your home is above 250 ppm/14.6 gpg, a water softener has to be fitted to maintain the performance of your dishwasher.

If your home has naturally soft or softened water...

- Avoid using too much detergent. Follow the quantity recommendations on the following page.
- Ensure the dishwasher is not overloaded and water can reach all the dishes.

32 Wash programmes and detergent quantities

- The quantities in the table below are for powdered detergent and typical levels of soiling. If your home has softer or harder water, or to suit the particular load, you may need to adjust these quantities.
- If you are using tablets, follow the tablet manufacturer's recommendations.

SYMBOL (CC model)	PROGRAMME	RECOMMENDED LOAD	QUANTITY OF POWDERED DETERGENT FOR EACH COMPARTMENT grams	
			 MAIN WASH	 PRE-WASH
	AUTO <i>(available in CC models only)</i>	Any type of load. The dishwasher automatically selects the optimum wash programme	<i>20-35 g depending on soils</i>	<i>none</i>
	Heavy	Heavily soiled pots, pans, baking dishes	<i>35 g</i>	<i>5 g</i>
	Normal	Dishes with normal soils for optimum wash and dry performance	<i>35 g</i>	<i>5 g</i>
	Normal Eco	Normally soiled dishes for optimum energy and water usage	<i>27.5 g</i>	<i>5 g</i>
	Fast	Very lightly soiled mixed dishes	<i>20 g</i>	<i>none</i>
	Delicate	Lightly soiled delicate (e.g. heat-sensitive) items	<i>20 g</i>	<i>none</i>
	Rinse	Prevents odours and soils drying on dishes before they are washed	<i>none</i>	<i>none</i>
	Hygiene <i>(available in CC models only)</i>	To sanitise your dishes and glassware	<i>35 g</i>	<i>5 g</i>

Important!

- Only use detergents recommended for automatic dishwashers.
- Dishwasher detergents are strongly alkaline. They can be extremely dangerous if swallowed. Avoid contact with the skin and eyes and keep children and infirm persons away from the dishwasher when it is open. Check that the detergent dispenser is empty after completion of each wash programme.
- Never sprinkle or pour detergent directly onto any item in the dishwasher. Detergent and dishwasher tablets should not be in direct contact with dishes or cutlery.
- Do not use hand washing liquids, soap, laundry detergents or disinfectants, as these will damage the dishwasher.

Filling the detergent dispenser

- 1 Press the button on the right of the dispenser.



Important!

Approach the dispenser from the right-hand side to prevent the cover from snapping open on your hand.

- 2 Add detergent into the appropriate compartment(s). If you are using powdered detergent, see the recommended quantities on the previous page. The '20' and '30' markings in the main wash compartment correspond to grams of powdered detergent.

Important!

Tablets should only be placed in the main wash (larger) compartment.

- 3 Remove any excess detergent from the edges of the dispenser.
- 4 Close the cover and press down until it clicks shut.
The detergent will automatically be released into the dishwasher during the wash programme.
- 5 *CC models only:* Ensure that the 'Detergent type'  in the 'User preference settings'  is set to the type of detergent you are using. For example, If you are using a multi-purpose tablet with rinse aid, we recommend selecting this setting in the 'Detergent type option', as doing so will prevent excess foaming. See section 'User preference settings' for instructions.

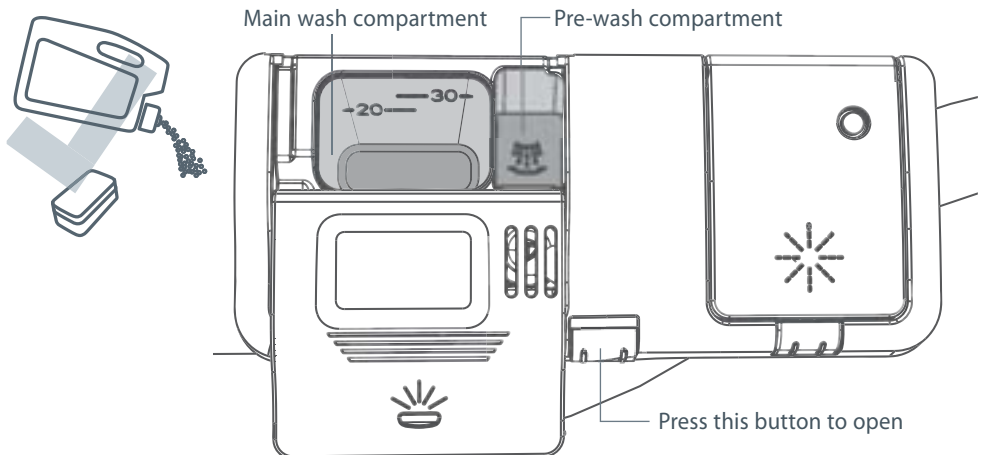

34 Using rinse aid

We highly recommend using liquid rinse aid regularly to get the best drying results. Rinse aid gives a streak-free, sparkling clean look to glass and chinaware. In addition, it prevents metal from tarnishing.

When to refill the rinse aid dispenser

When rinse aid level becomes low, the rinse aid indicators on the dispenser and the control panel will light up to remind you to refill the dispenser.

Adjusting the rinse aid dosage

The normal, factory-set dosage level is 4, but you may need to adjust this to suit your water conditions. Insert a flat-bladed screwdriver into the slot of the dosage regulator arrow, and turn it to the desired level.

- If there is excessive foaming at the end of the wash, reduce the dosage.
- If you live in a hard water area or if dishes are wet or streaky after drying, increase the dosage.
- If you are using tablets with built-in rinse aid, we recommend setting the rinse aid dosage level to 1. On CC models, you may wish to turn the rinse aid off altogether and/or select the correct detergent type (tablet with rinse aid).

See section 'User preference settings' for how to do this.

How to refill the rinse aid dispenser

- 1 Press the button to snap the dispenser cover open.
- 2 Pour rinse aid into the circular opening, making sure not to fill beyond the MAX marking.

Important!

Take care not to spill rinse aid into the dishwasher. Any spills must be wiped up to prevent excess foaming. Failure to do so may result in a service call, which will not be covered by warranty.

- 3 Close the cover, making sure it clicks shut.

Rinse aid indicators

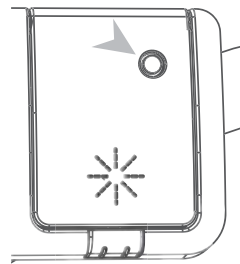

CE models only



CC models only

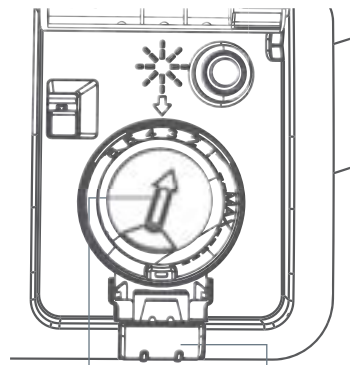

Dosage regulator

Press to open

When the wash programme is over, the dishwasher will beep six times, then automatically turn off in a few seconds. In CC models, a drying fan will continue to run for about an hour, or until the door is opened.

- 1 Open the door slightly and leave it ajar (about 100 mm) to help the drying process.
- 2 Once the dishes are cool to touch, they can be removed.

Important!

Never leave the dishwasher door in the fully open position, as this could present a tripping hazard.

- 3 Check that the detergent dispenser is completely empty. If it isn't, wipe out with a damp cloth.
- 4 Inspect your dishwasher regularly to see if it needs any cleaning or maintenance:
 - Check that no grease or limescale deposits have accumulated on the inside.
 - If there are food particles in the filters, these need to be cleaned as well.
 - See section 'Care and cleaning' for cleaning and maintenance instructions.

Holiday time

If the dishwasher is not going to be used for some time:

- Ensure the baskets are empty.
- Leave the inside of the dishwasher clean.
- Leave the dishwasher door ajar to allow air to circulate.
- Turn off both the power and water supply to the dishwasher.

Over time, food residue or limescale deposits may accumulate inside your dishwasher. These may reduce efficiency, and food residue may produce a bad odour. Inspect and clean your dishwasher regularly.

Important!

- *Before any cleaning or maintenance, always disconnect the dishwasher from the power supply, turn off the water supply, and wait until all parts of the dishwasher have cooled.*
- *Do not use the following cleaning aids, as they may damage the surfaces:*
 - plastic or stainless steel scouring pads*
 - abrasive, solvent, household cleaners*
 - acid or alkaline cleaners*
 - laundry detergents or disinfectants*
 - stainless steel cleaners or polishes*
 - hand-washing liquids or soap*
- *Where there is broken crockery or glass in the dishwasher, it must be carefully removed to prevent personal injury or damage to the appliance.*
- *After cleaning, always check that the spray arms and filters are all correctly in place.*

Cleaning the dishwasher exterior

Wipe with a clean, soft damp cloth and dry with a clean, lint-free cloth.

Note: before cleaning the control panel, it is useful to disable the buttons by activating Keylock.

Cleaning the door seal and dishwasher interior

Clean thoroughly with warm water on a soft, lint-free cloth. If the interior is heavily soiled, use a dishwasher cleaner/descaler following the manufacturer's instructions.

Cleaning the filters

The filters prevent larger food particles in the wash water from reaching the pump. These particles may occasionally block the filters. We recommend cleaning the filters whenever there is evidence of food particles.

- Remove the filters, as shown, then rinse them thoroughly under running water.

Important!

When cleaning the underside of the filter plate, take care handling its sharp outer edge.

- Replace the filters correctly after cleaning, making sure the filter plate is flush with the dishwasher base.

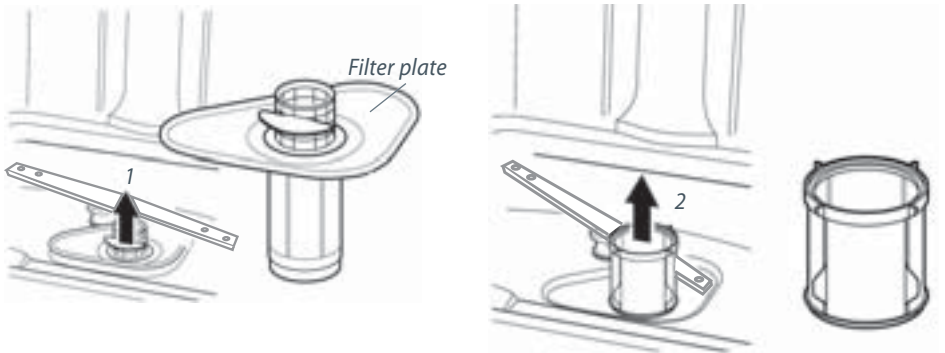

Cleaning the spray arms

Limescale and food particles in the wash water can block the holes in the spray arms and the arm mountings. Clean these parts about once a month, or more often should the need arise.

- To remove the upper spray arm, unscrew its locking nut.
- To remove the lower spray arm, unscrew its locking nut and lift the spray arm off its mounting.
- Rinse the spray arms thoroughly under running water, then refit them on their mountings. Make sure that you twist the locking nuts firmly back on.

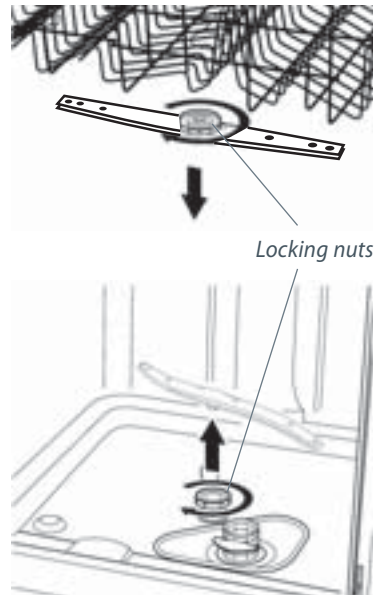

If the dishwasher malfunctions, it will display a fault code and beep. Check the table below to see if you can correct the fault yourself before contacting Fisher & Paykel Customer Care.

If the dishwasher still will not work, or shows any other fault code

- 1 Press ① to turn the dishwasher off and wait a few minutes.
- 2 Press ① again to turn the dishwasher back on.
If the dishwasher still does not function and/or the problem persists, disconnect the dishwasher from the power supply, turn the water supply off, then contact Fisher & Paykel Customer Care with the fault code information.

Fault codes and descriptions	Possible causes	What to do
E1 <i>The door is open</i>	The door has not been properly closed or steam has forced it open.	Close the door firmly.
E2 <i>Sensor fault</i>	The temperature sensor is faulty.	Turn the water and power to the dishwasher off, then call Customer Care.
E3 <i>Drain hose fault</i>	The drain hose is not connected properly or has come loose.	Ensure that the drain hose is connected in accordance with the installation instructions.
E4 <i>Drain fault</i>	Drain hose is crimped or bent.	Check the drain hose and straighten if needed.
	The waste water is not draining out.	Ensure that the drain hose is connected in accordance with the installation instructions.
E5 <i>No water</i>	Water tap not turned on.	Ensure the water is connected and turned on.
	Insufficient water supply pressure.	Check household water pressure.
	Water inlet hose is crimped or bent, so no or not enough water gets to the dishwasher.	Check the water inlet hose and straighten if needed.
	Drain hose is not connected correctly.	Ensure that the drain hose is connected in accordance with the installation instructions.
E6 <i>Flooding</i>	Flood switch activated.	Turn the water off and disconnect the dishwasher from the power supply. Call Customer Care.

Problem	Possible cause	What to do
Dishwasher will not start.	No power.	Ensure the dishwasher is plugged in and the power supply is turned on at the wall.
	The door is not properly closed.	Close the door.
	Start/Pause button ► has not been pressed.	Press the Start/Pause button ► .
	Water tap not turned on.	Ensure water is connected and turned on.
	Blocked strainer in water inlet hose.	Check the strainer and clean if necessary—it is located where the water inlet hose screws into the tap.
	Keylock is activated.	Cancel Keylock by pressing and holding ① for 3 seconds.
Lower spray arm rotates with difficulty.	Spray arm holes are blocked by small items or food particles.	Clean the spray arm. See 'Care and cleaning' for instructions.
Cover of detergent dispenser cannot be closed.	Detergent compartment has been overfilled.	Remove detergent until the cover can be closed.
	Detergent dispenser is clogged with remnants of detergent.	Wipe dispenser out with a damp cloth. Dry the dispenser before adding detergent.
Remnants of detergent stuck inside dispenser.	Compartment was damp when filled with detergent.	Wipe dispenser out with a damp cloth. Dry the dispenser before adding detergent.
Buttons beep and do not respond.	Keylock is activated.	Cancel Keylock by pressing and holding ① for 3 seconds.
Water remains inside dishwasher after wash has ended.	Drain hose is crimped, bent, or blocked.	Check the drain hose and straighten if needed.
	Pump is jammed.	Call your Fisher & Paykel Authorised Service Centre or Customer Care.
	Filter(s) blocked.	Clean the filter(s). See 'Care and cleaning' for instructions.
Foaming.	Incorrect amount or type of detergent used.	See section 'Adding detergent' or consult the detergent manufacturer's instructions.
	Too much egg in the wash load.	Increase the amount of detergent.
	Rinse aid dosage level too high.	Decrease the rinse aid dosage.
	Rinse aid spills not wiped up.	Ensure that all rinse aid spills are wiped up when they occur.
The dishwasher stops suddenly during the wash.	Power or water supply has been interrupted.	Check the power and water supplies.

Problem	Possible Cause	What to do
Knocking or rattling sound during wash.	Spray arm knocking against dishes.	Pause the wash and rearrange dishes. See sections 'Controls and starting a wash' and 'Loading'.
	Dishes have been stacked incorrectly.	
Unclean dishes.	Wash programme unsuitable for load.	See section 'Wash programmes and detergent quantities' and select a suitable programme.
	Soils were too heavily baked on.	Dishes may need soaking.
	Spray arm(s) unable to rotate.	Ensure no items are obstructing the spray arm path.
	Dishwasher overloaded or incorrectly loaded.	See the 'Loading' section.
	The filters are incorrectly inserted.	See section 'Care and cleaning'.
	Detergent put in the wrong compartment.	See sections 'Wash programmes and detergent quantities' and 'Adding detergent'.
	Excessive food not removed from dishes before loading.	Scrape all food scraps off dishes before loading.
	Unsuitable detergent.	Only use powdered or tablet detergent designed for domestic dishwashers.
	Not enough detergent.	See 'Wash programmes and detergent quantities' for recommended quantities. You may need to adjust these to suit your particular load and the hardness of your water supply.
	Spray arm holes are blocked.	Clean the spray arm(s). See 'Care and cleaning' for instructions.
The filters are blocked.	Clean the filters. See 'Care and cleaning' for instructions.	
Plastic items are discoloured (e.g. stain left by tomato sauce).	Not enough detergent, not pre-rinsed.	Pre-rinse plastic dishes before placing in the dishwasher and/or add more detergent. Alternatively, using the Rinse programme after adding dishes may minimise staining.
White stains are left on dishes; glasses have a milky appearance.	Not enough detergent.	See section 'Wash programmes and detergent quantities' for recommended quantities. You may need to adjust these to suit the hardness of your water supply.
	Rinse aid dosage too low.	Increase rinse aid dosage. See 'Using rinse aid'.

Problem	Possible cause	What to do
Dishes, cutlery have not dried.	Rinse aid dosage too low.	Increase rinse aid dosage. See 'Using rinse aid'.
	Items removed too soon.	After the end of the wash programme, leave the door ajar and wait for several minutes to help drying.
	Rinse aid dispenser empty. (The rinse aid indicators are lit.)	Add rinse aid. See section 'Using rinse aid' for instructions.
Glasses have dull appearance.	Rinse aid dosage too low.	Increase rinse aid dosage. See 'Using rinse aid'.
Tea stains or traces of lipstick have not been completely removed.	Not enough detergent.	See section 'Wash programmes and detergent quantities' for recommended quantities. You may need to adjust these to suit your particular load.
	Wash temperature too low.	Select a wash programme with a higher temperature (see section 'Wash programme data' for information).
Traces of rust on cutlery.	Cutlery is not sufficiently rustproof.	Wash by hand.
Glasses clouded and discoloured; milky coating	Hard water situation.	Increase detergent quantities.
	Glasses are not dishwasher proof.	Wash by hand.
Water marks left on glasses and cutlery.	Rinse aid level or dosage setting is too low.	Ensure there is rinse aid in dispenser. If necessary, increase the rinse aid setting or try using a wash programme with a higher temperature. See sections 'Using rinse aid' and 'Wash programme data'.
Fan noise coming from the dishwasher after a wash (CC models only).	This is normal. A drying fan will continue to run for about an hour after a wash or until the door is opened.	No action required. If you would like the drying fan to stop, open the dishwasher door.

42 Warranty and service

Before you call for service or assistance ...

Check the things you can do yourself. Refer to the installation instructions and your user guide and check that:

- 1 your product is correctly installed
- 2 you are familiar with its normal operation.

If after checking these points you still need assistance, please refer to the Service & Warranty book for warranty details and your nearest Authorised Service Centre, or contact us through our local website listed on the back cover.

Fisher & Paykel Appliances

Model Serial no.

Date of purchase Purchaser

Dealer Suburb

Town Country

CE and CC models

	Heavy	Normal	Normal Eco*	Fast	Delicate	Rinse
Stages	pre-wash	pre-wash	pre-wash		pre-wash	pre-wash
	main wash 70°C	main wash 55°C	main wash 46°C	main wash 40°C	main wash 45°C	
	post-rinse 1	post-rinse 1	post-rinse	post-rinse	post-rinse	
	post-rinse 2					
	post rinse 65°C	post rinse 65°C	post rinse 43°C	post rinse 50°C	post rinse 60°C	
	drying	drying	drying	drying	drying	

*reference programme for energy label compliance with AS/NZS 2007

CC models only

	Auto	Hygiene
Stages	pre-rinse (where necessary)	pre-rinse
	main wash 50-65°C	main wash 65°C
	post-rinse	post-rinse
	post-rinse (if required)	post rinse 70°C
	post rinse 65°C	
	drying	drying

44 Standards test

The dishwasher is tested to AS/NZS 2007 standards for both wash and dry performance using the parameters detailed below.

Wash programme	Normal Eco <i>When the programme is finished, open the door 100mm to help with drying</i>
Powdered detergent quantities	5 g pre-wash + 27.5 g main wash
Rinse aid dosage level	5
Maximum number of place settings	14
Height adjustment of upper basket	<i>Ensure the upper basket is in its uppermost position</i>

Recommended loading patterns



Upper basket



Lower basket

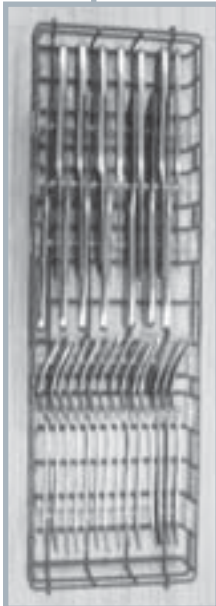

Utensil tray

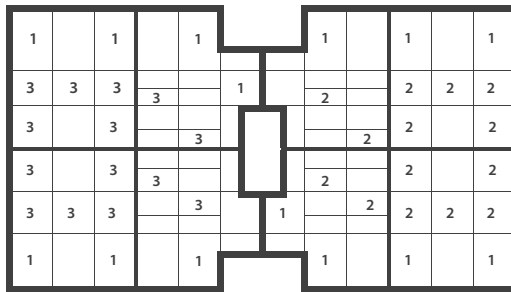

Cutlery basket



www.fisherpaykel.co.nz
www.fisherpaykel.com.au
www.fisherpaykel.com.sg

Fisher & Paykel

Copyright © Fisher & Paykel 2012. All rights reserved.

The product specifications in this booklet apply to the specific products and models described at the date of issue. Under our policy of continuous product improvement, these specifications may change at any time. You should therefore check with your Dealer to ensure this booklet correctly describes the product currently available.